

Article number: 20291150315L2SCR

Description: E+G Linear actuators - GN 291.1-50-315-L2-SCR

Measures

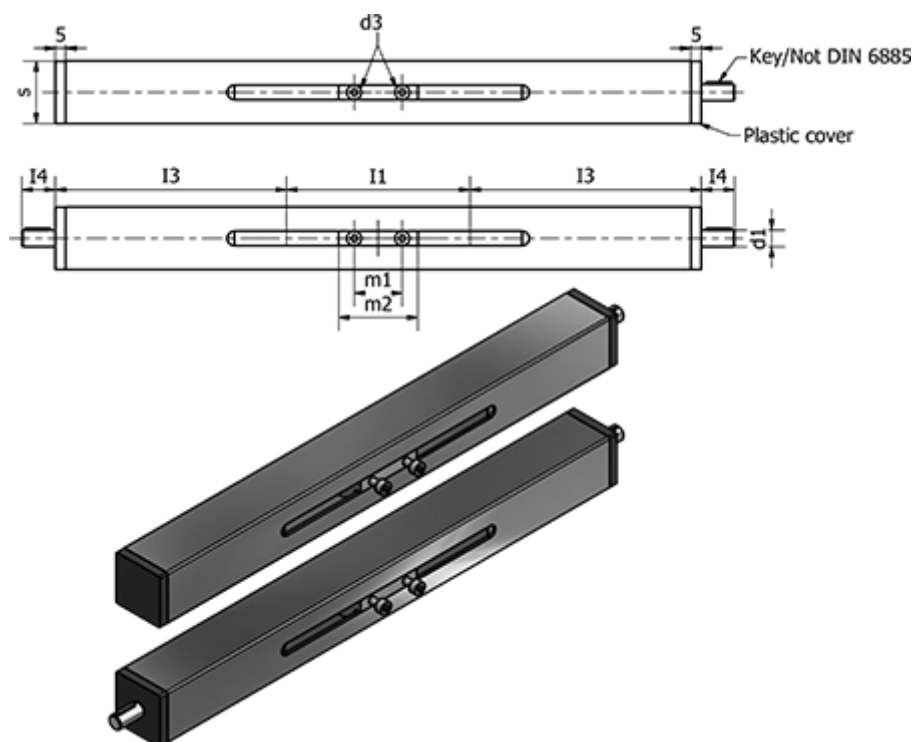

d1 f7 = 12

d2 = M6

I1 = 315

I2 = I2+245

I3 = 122.5

I4 = 18

m1 = 42

m2 = 54

Max. travel = 1565

s = 50

Shaft key DIN 6885 = A4x4x12

Shaft thread = TR20x4